

**BRETON**



CAMA  
**AFETTO**



CAMA  
AFETTO

BRETON

# CAMA

CAMA SOLTEIRO

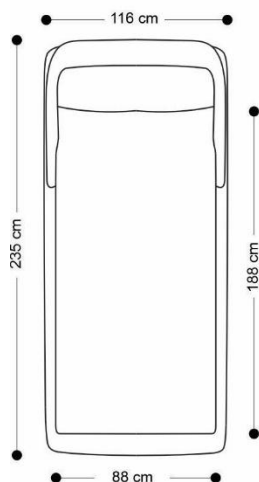
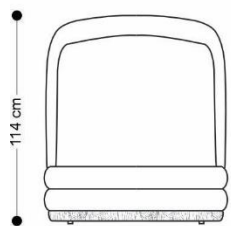

CAMA QUEEN SIZE

CAMA VIUVA

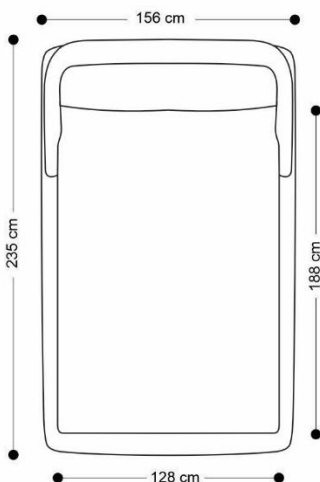
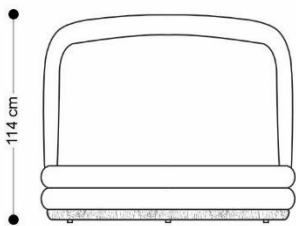

CAMA KING SIZE

CAMA CASAL

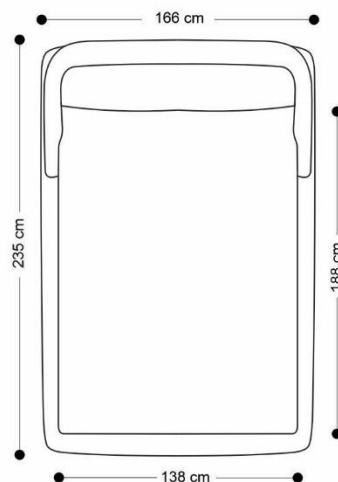
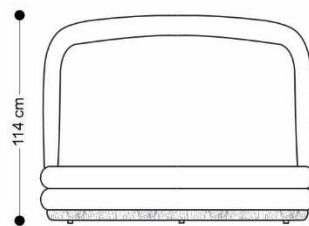

CAMA SUPER KING SIZE

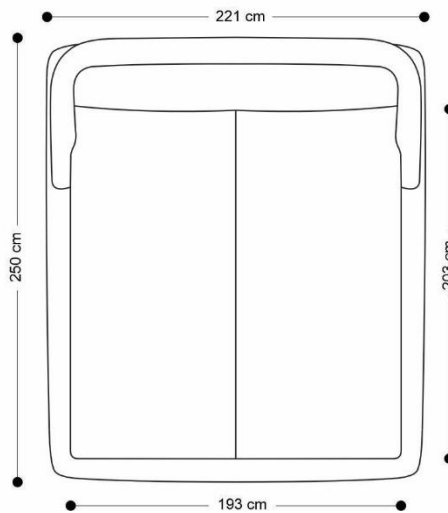
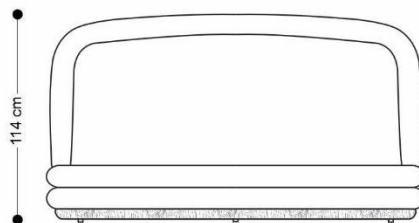
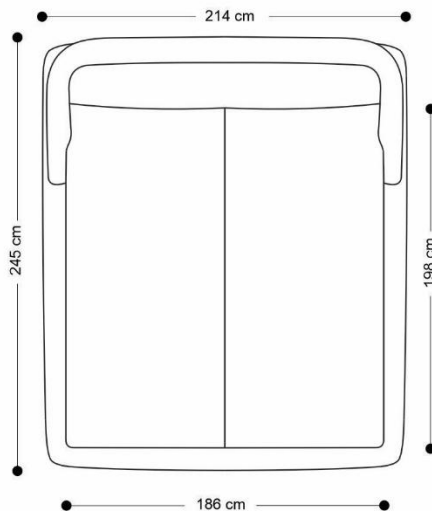
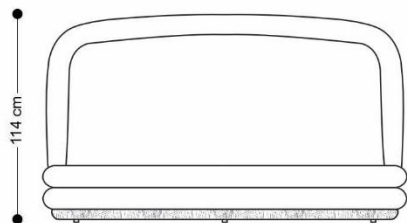
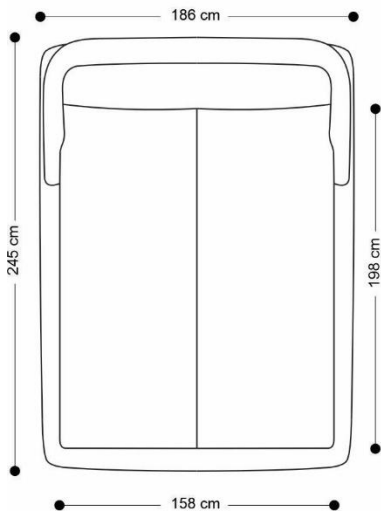
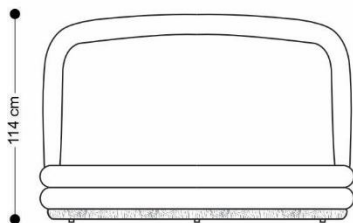

CAMA  
AFETTO

BRETON

# CAMA

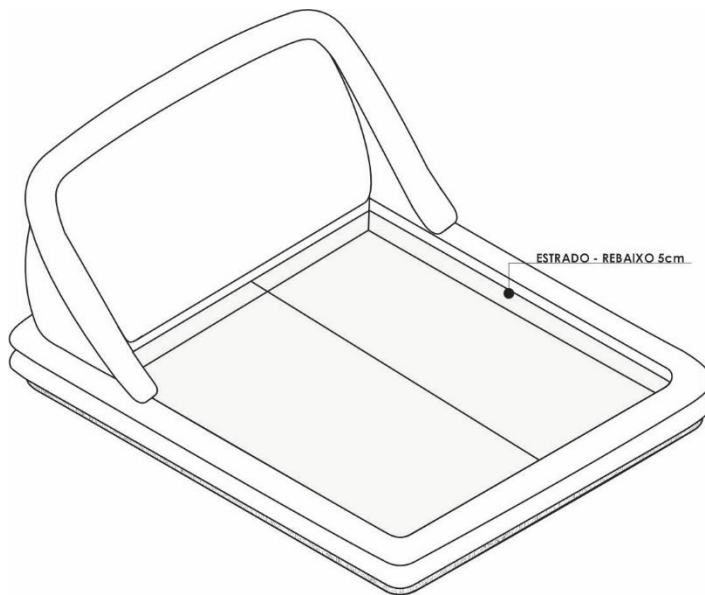
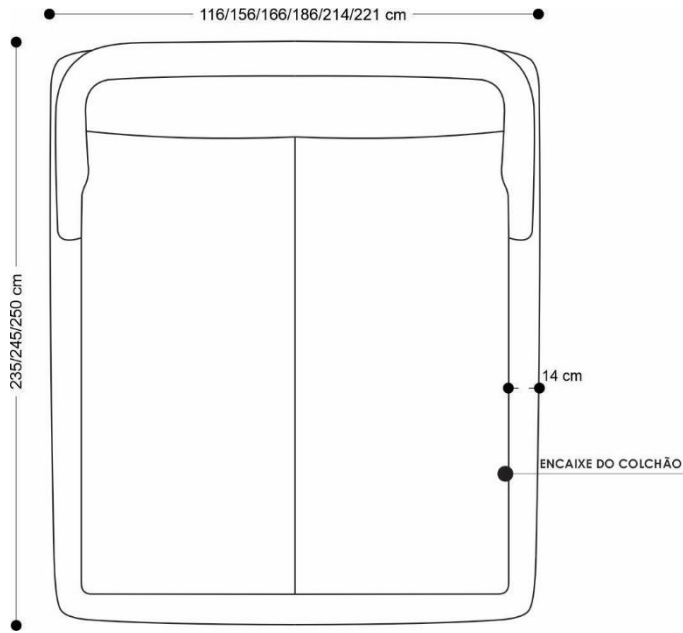
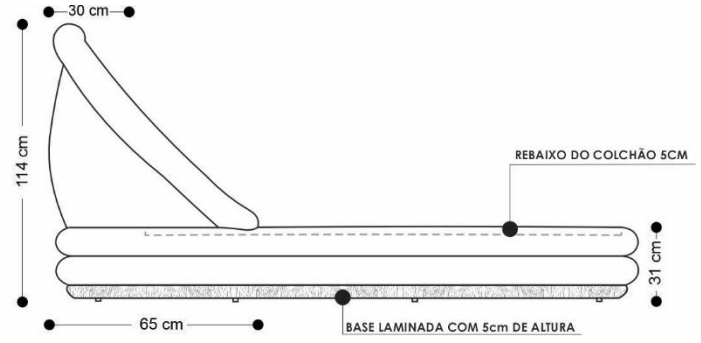
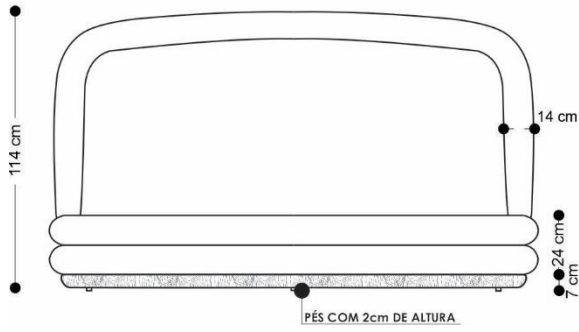

CAMA  
AFETTO

BRETON

## Diferenciais:

- Curvas no encosto e no box dão um visual fluido
- Base em madeira traz um toque natural a cama



CAMA  
**AFETTO**

**BRETON**

 Em madeira de reflorestamento tratada com controle de umidade, compensado naval , fixados com grampos. Enchimento da cabeceira em poliuretano D20 Soft e D26, enchimento do box em poliuretano D26. Base em madeira laminada com pés em aço carbono preto.

Tecidos com baixa elasticidade altera a característica do produto apresentando franzimentos. A profundidade do produto altera conforme o tamanho da largura.

 Made from treated reforested wood with moisture control, marine plywood, and fastened with staples. The headboard filling is made of D20 Soft and D26 polyurethane foam, and the box filling is made of D26 polyurethane foam. The base is made of laminated wood with black carbon steel legs.

Fabrics leather with low elasticity alter the characteristics of the product, presenting puckers. The depth of the product changes depending on the width.

 Fabricado con madera de reforestación tratada con control de humedad, contrachapado naval y fijado con grapas. El relleno del cabecero está hecho de poliuretano D20 Soft y D26, y el relleno del box está hecho de poliuretano D26. La base está hecha de madera laminada con patas de acero al carbono negro.

Los tejidos sintética con baja elasticidad alteran las características del producto, presentando fruncidos. La profundidad del producto cambia según el ancho.